

FPS2800B12C4

OIL PROPERTY SENSOR



Features

- Rugged construction for high pressure and high flow environments
- On-board microprocessor for real-time data analysis with 12-24 volts supply
- Highly reliable and long term stability

Applications

- Engine, transmission and hydraulic oils for on and off-highway vehicles

Installation guideline

- Fully integrated, stand-alone module sensor and processing electronics
- Accurate, repeatable temperature, viscosity, density and dielectric constant
- Factory calibrated with NIST traceable fluids
- Digital output based on J1939, CAN2.0B standard featuring high-resolution parameter readings

Description

The FPS2800B12C4 is an oil property sensor that will directly and simultaneously measure the viscosity, density, dielectric constant and temperature of low conductivity fluids. Relying on tuning fork technology, the sensor monitors multiple physical properties that enables the OEM to determine the quality, condition and contaminant loading of fluids such as engine oil, transmission, hydraulic and gear oils. The multi-parametric analysis capability improves fluid characterization algorithms. The FPS provides in-line monitoring of fluids for a wide range of OEM and aftermarket installations including fluid reservoirs, process lines and pressurized high flow conduits (e.g., engine oil gallery) for applications that include on and off highway vehicles, HVAC&R, compressors, industrial equipment and turbines. A universal digital CAN J1939 based protocol provides easy to connect interface to main Host controller. A simple four pins connector allows for cost effective mounting options.

This document describes the installation of the oil property sensor FPS2800B12C4. The FPS directly measures oil properties and temperature at the same time of various fluids. The FPS is a robust and reliable sensor that provides multi-parametric analysis of fluids in a wide range of installations. This guide details the installation steps and basic recommendations that will maximize the long-term performance of the sensor.

1. Ordering Information

Description	Part Number
FPS2800B12C4	FPP800A110

2. General precaution

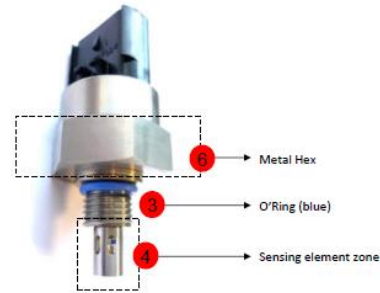

Figure 2.1 : FPS2800 overview

1. FPS sensor should remain in the carrier packaging until set-up on the application. If removed from the system, the FPS sensor must be placed back in its carrier packaging.
2. Do NOT remove the plastic protective cap of the probe before its final installation into equipment or line. In order to avoid any damages to the sensing element, handling precautions have to be implemented
3. Before set-up, a visual check should ensure the O-Ring is present in the FPS sensor groove (see picture 2.1).
4. To avoid any damages to the sensing element, handling precautions have to be implemented. Any installation tools or operators hands should never touch the sensing element zone (see picture 2.1).
5. If sensor falls during set-up procedure realization, the sensor should be rejected and not set-up on the application.
6. The set-up mounting or dismounting torque should be applied to the FPS sensor body (metal Hex) and should never be applied to the sensor connector itself (see picture 2.1).

CAUTION:

Do NOT push; poke or otherwise touch the tuning fork with any object or instrument, as this may cause huge damage to the Sensor.

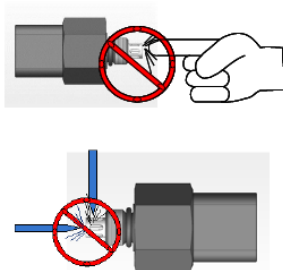

Figure 2.2

NOTE: Customer's standard procedures recommends the use of thread locking fluid or gel regarding integration of M14 stainless steel part on their machines or systems.

CAUTION: Contact between thread locking fluid or gel and the wetted parts of the sensor have to be avoided very carefully (tuning fork, RTD and protective shroud).

SAFETY NOTE:

Sensor installation points may be hot, fluids may be under pressure and high flow and/or fluids may be chemically aggressive or corrosive. Protective equipment and security procedures should be used when making sensor installations and dismantling.

3. Recommended application

Prior to installation, the customer must confirm with TE that the sensor is suitable for the application.

The FPS was built to operate in hydrocarbon-based liquids such as lubricants which characteristics have been validated both by TE and by customers prior to installation. The FPS can be typically used in liquids which are engine, hydraulic, compressor, transformer, gear and transmission oils on the condition that their properties comply with the indicated measurement ranges for each of the measured parameters.

Any use of the FPS in a different application than the above description is not suitable, unless TE Connectivity (TE) and customers

have both agreed on the suitability of this new application. Measurements in non-Newtonian, conductive - like aqueous or ionic solutions-, multi-phases or corrosive liquids should not be performed. The FPS should always be handled in accordance with the instructions in the owner's manuals, whenever it is in use or shipment.

Contact TE for special applications.

4. Description

1. Weight

Total weight < 90 g.

2. Dimensions

All dimensions are given in millimeters.

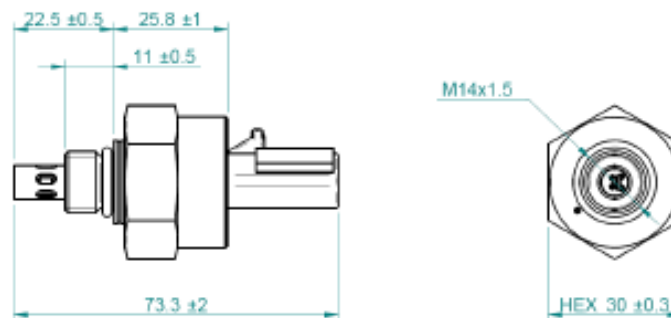

Figure 4.1: FPS2800C4 dimension

5. Environment conditions

1. Temperature

Continuous operating temperatures:

- Sensor electronics: -40 to +125°C
- Oil temperature: -40 to +150°C

Be careful, above 150°C, materials soldering are not qualified.

2. Pressure

The sensor head is fully functional over a pressure range: $0 \text{ bar} \leq P \leq + 25 \text{ bars}$ (375 psi). Please contact TE for applications requiring higher-pressure ratings.

3. Physical oil properties

Continuous operating:

- Dynamic viscosity: 0.0 to 50.0 cP
- Density: 0.000 to 1.500 gm/cc
- Dielectric constant: 1.00 to 6.00
- Oil temperature: -40°C to +150°C

4. Storage

The FPS must be stored with protection material as used for the shipment. Do not forget to put the probe protection.

Storage temperature range: -50 to + 150°C.

5. Vibration

Continuous operating: 0 to 20 Grms.

6. Media examples

Lubricants, Oils, Process fluids

7. Casing

Description	Part Number	Mating connector
FPS2800B12C4	FPP800A110	FCI female receptacle ref. 54200409 (black-sealed).

- Sensor with mating connector is IP 68 rated when assembled.
- Sensor body is stainless steel.
- Threaded Adapter Fitting (M14x1.5) with O-Ring Seal.

6. Electrical description, output characteristics

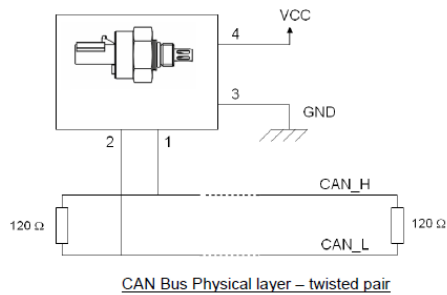

Figure 6.1 :Sensor output schematic

- Supply voltage: minimum 9 VDC, typical 12 or 24 VDC and maximum 36 VDC.
- Power consumption : < 100mA, typical 70 mA for 12 VDC power supply.
- CAN Bus physical media: These 2 wires have a characteristic impedance of 120 Ω and are symmetrically driven with respect to the electrical currents.

7. Dimensions, mechanical interface and mounting guidelines

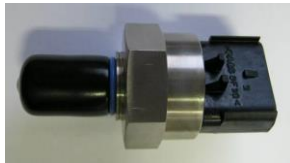

Figure 7.1 : sensor with protective cap

Take care while removing the protective cap of the probe.

This should be done only when the probe will be placed in the fluidic interface.

SAFETY NOTE:

Sensor installation points may be hot, fluids may be under pressure and high flow and/or fluids may be chemically aggressive or corrosive. Protective equipment and procedures should be used when making sensor installations and dismantling.

1. Sensor mounting proposal

Mounting torque: 27Nm, +/- 5.4 Nm (torque wrench is recommended for mounting)

CAUTION: This specification has to be accurate and confirmed in the application mounting system.

Customer's standard procedures recommends the use of thread locking fluid or gel (e.g., Loctite®) regarding integration of M14 stainless steel part on their machines or systems.

CAUTION: Contact between thread locking fluid or gel and the wetted parts of the sensor must be avoided very carefully (tuning fork, RTD and protective shroud).

Mounting envelope: "Mounting specifications as per SAE J2244"

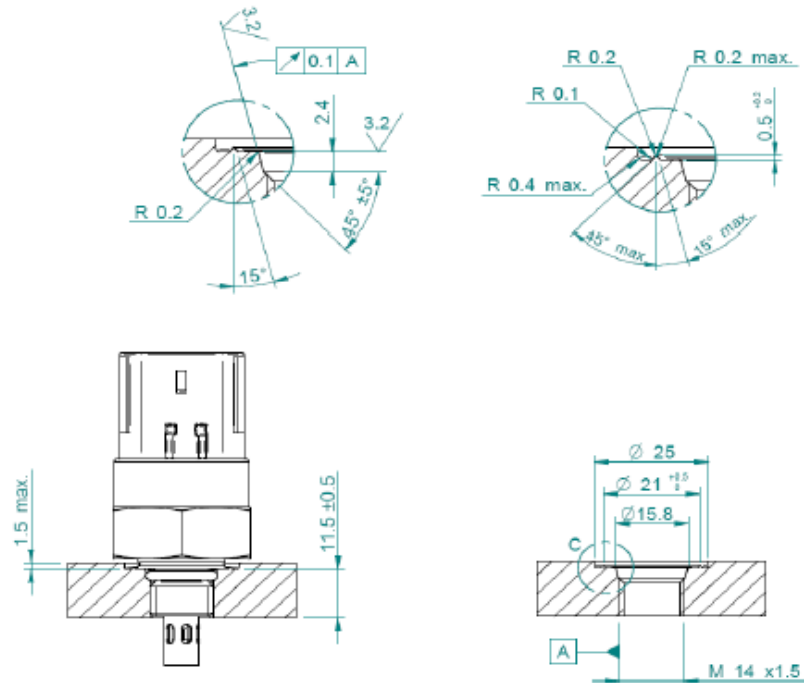

Figure 7.2: mounting envelope

2. General caution

It is important to install the sensor in an orientation or position that would minimize the potential of air or particles entrapment around the sensing element. If air-bubbles, particles or an air-pocket forms around the sensing element, it will cause the sensor to measure the combined gas & oil properties as exposed under test.

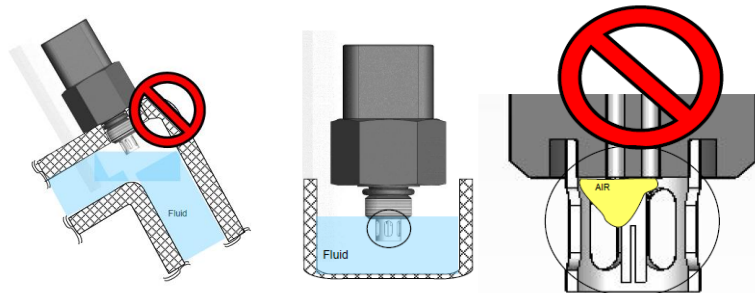

Figure 7.3 : Schematic of the FPS2800 placed in the liquid

3. In line test and mounting position

The physical orientation of the sensor will have no direct impact on the performance. While the sensor can be mounted in a fluid at any angle, for optimum long-term performance on engine or heavy wear applications, the pressure side of the oil gallery is optimum to keep a steady and consistent oil-flow across the sensing element to best represent the oil condition seen by the lubrication system.

The sensor should be oriented in a manner that air/moisture/particles etc. are not collected around the sensing element. This means avoid installation in “dead-head” locations (i.e., recessed drill ports). If air/particles are trapped around the sensing element it can eventually result in poor output or in other ways possibly damage the sensor or distort the signal and result in unexpected measurement data. To minimize the above-described risks, the sensor should always be mounted in such a way that air / particles can be naturally evacuated and are not collected around the sensing element.

Installation depth in the inlet tube or manifold shall be done in such manner that the sensor shroud openings are located in the primary flow stream and free from any obstacle or obstruction of flow after assembly in the manifold.

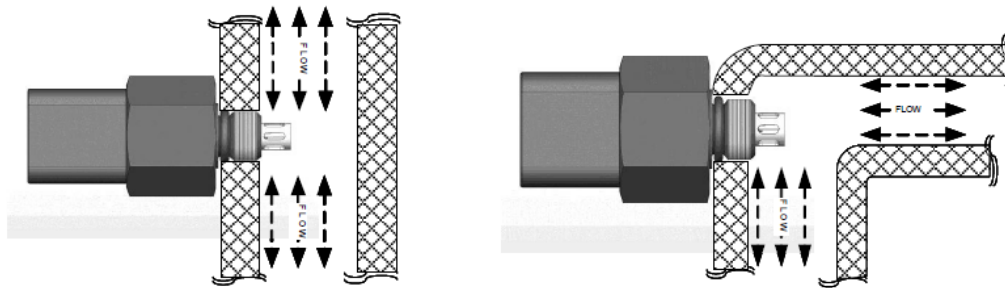

Figure 7.4: Schematic of the FPS2800 placed in the flow

4. Laboratory test and mounting position

The sensor may also be used in an open system or beaker to test oil samples for lab bench applications. When performing beaker or lab bench testing, it may be necessary to shake the sensor in the fluid to displace any air trapped in or around the sensor shroud that could interfere with the sensing element contacting the oil under test.

An agitation system is highly recommended to secure the homogeneity of the temperature inside the beaker, and guarantee the good mixture of the solution.

An “oil temperature bath” system can be used in order to secure the temperature ramp up.

Some recommendations to secure lab measurements:

- The oil needs to be in the specification ranges (Dynamic viscosity, Density, Dielectric Constant and Temperature)
- The temperature needs to be adapted according to the viscosity range of the sensor (0-50cP) and stabilized during measurements
- The homogeneity of the solution needs to be secured with an agitation system (for the temperature, contaminations, ...)
- We can use a thermal bench in order to secure temperature variations
- Have a good cleaning process for the sensors with alcohol (like isopropanol), rinse with Deionized Water + slight drying of sensing elements

For example, we can use a heater with magnetic stirrer (See figure 7.5), or a specific Thermal Bench to have a controlled temperature (See figure 7.6).

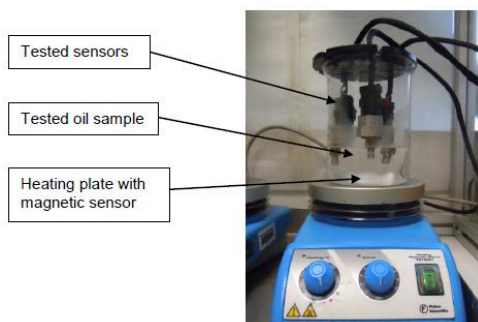

Figure 7.5 : Example of lab testing – with magnetic stirrer

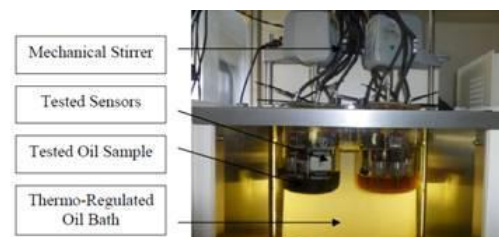

Figure 7.6: Example of lab testing – with thermo-regulated bench

CAUTION:

Without agitation system, the solution is not homogenous around sensing elements and can slightly affect accuracy. For any static condition, please contact TE before testing.

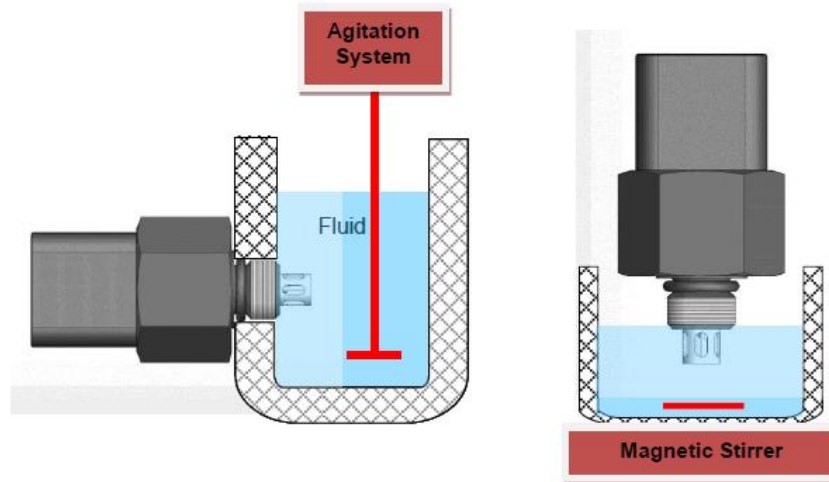

Figure 7.7: Example of lab testing – with agitation system

5. Choice of location on engine or other mechanical systems

The preferred location is in the pressurized oil gallery, filter head or flooded conduits. Please take care that the sensor installation does not restrict flows below system design specifications.

For best performance, sensor should be mounted to optimize oil flow through sensor opening. Minimum considered flow should be 0.2m/s to insure rapid fluid exchange across the sensor element.

Minimize the risk of air, particulate loading at the sensor element and shroud.

Oil sump (pan) installations are not recommended if the oil in the sump becomes entrained with high volumes of air or gas during machine or system operation. This condition will not damage the sensor, but the sensor will be monitoring an “oil/air” emulsion vs. pure oil condition.

Avoid close proximity of uncontrolled and rapid changing heat sources for better metrological performance.

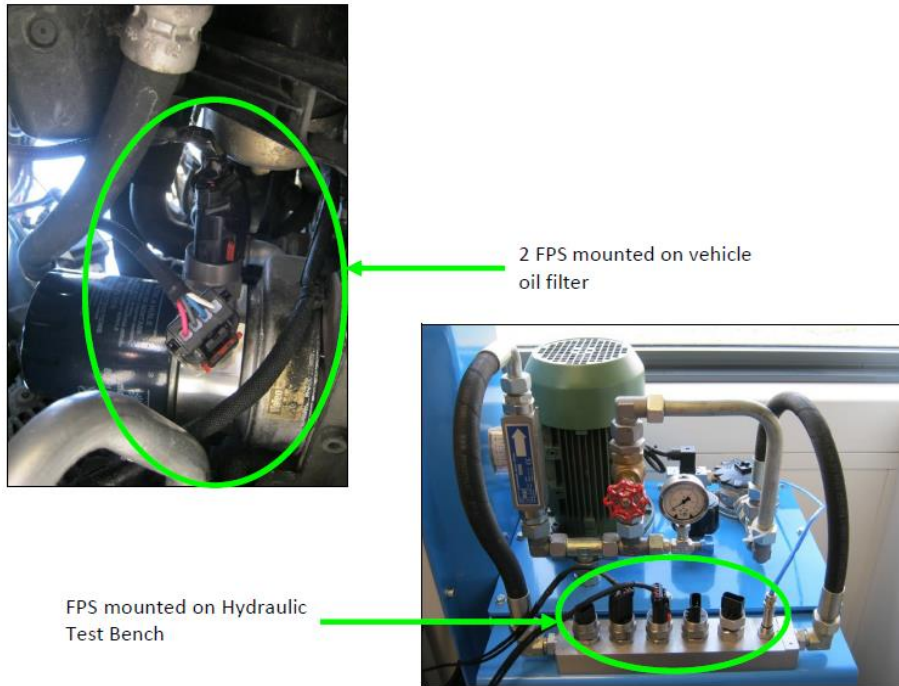

Figure 7.8: Example of application mounting – FPS2800 mounted on an engine (top left), FPS2800 mounted on hydraulic test bench (bottom right)

Some recommendations to secure field measurements:

- The temperature needs to be adapted according to the viscosity range of the sensor (0- 50cP), and stabilized during measurements
- Mounting system needs to be adapted regarding oil viscosity and velocity parameters. (See figure 7.9)
- Avoid air/particles entrapment around the tuning fork, and inside the shroud
- Sensor should be placed after a filtration system in order to avoid particles on tuning fork.

6. Oil flow velocity

For best performance, sensor should be mounted to optimize oil flow through sensor opening. Minimum considered flow should be 0.2m/s to insure rapid fluid exchange across the sensor element. Recommended mounting conditions in function of the Viscosity:

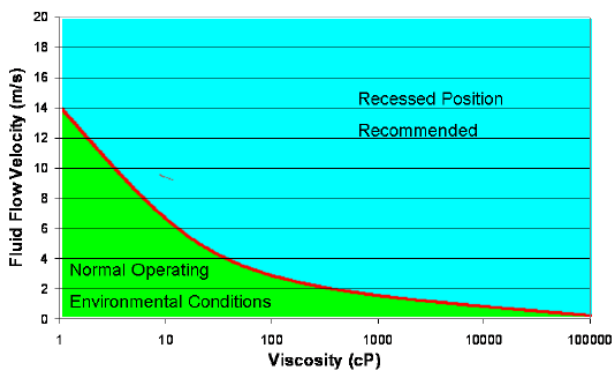

Figure 7.9 : Mounting position of the FPS2800 in function on oil flow velocity and viscosity - Transient/Starting environment

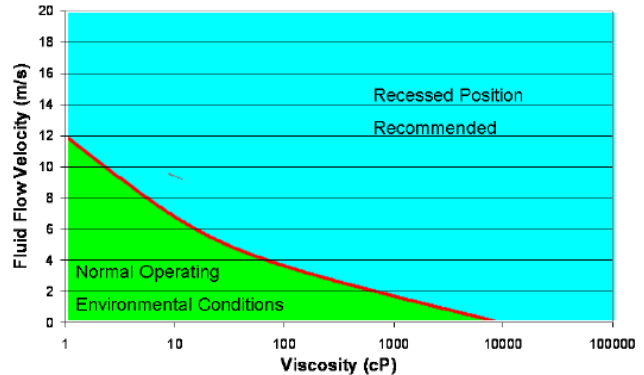

Figure 7.10 : Mounting position of the FPS2800 in function on oil flow velocity and viscosity – steady state environment

- Example of recessed mounting position:
 - Dimension 1 (shroud to pipe) = 3.5 mm
 - Dimension 2 (diameter) = 12.25 mm

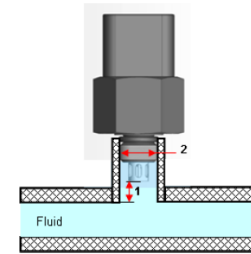

Figure 7.11 : Mounting position of the FPS2800 – example of recessed position

CAUTION:

Recessed position need to be adapted to each system. Dimensions are linked to the fluid pressure, viscosity, temperatures, fluid flow velocity and other parameters. Bad integration can create air bubbles.

For the recessed position, please contact TE before final integration.

Temperature gradient may occur between fluid in contact with sensitive element and outside air in contact with sensor body. A minimum of 0.2m/s oil flow is necessary to have a compatible mounting condition.

7. Sensor and connector protection

When the mating connector is not attached to the sensor, the integrated connector should always be protected from fluids, moisture, dust, and mechanical damage by means of a protection cap or similar. The connector should not be filled with grease. The wire harness needs to be clamped 50 - 150mm from the back of the connector.

The sensor and wire harness need to be routed, or protected so that they cannot be stepped on, pushed or pulled.

To minimize the risk of intrusion of water, particles, dust etc, especially to the integrated connector, and to minimize the risk for mechanical damage, the sensors should be located in a protected area.

The sensor element needs to be protected in a manner so that when it is removed from the fluidic interface and handled in a service shop that the sensor cannot be damaged due to handling. A protective cap (provided with sensor) should be used whenever the sensing element is not mounted or in use.

8. CAN specification for the FPS2800B12C4

1. Drawing

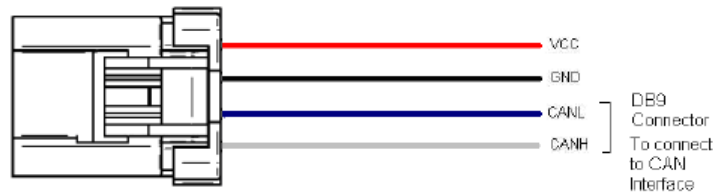

Figure 8.1: Electrical and CAN communication drawing

CAUTION:

A resistor (120Ω) must be placed between CAN High and CAN Low

2. Parameters

Oil properties output:

- PGN number: 0xFD08
- Source address: 0x3F
- Update period (s): 30
- Frame:

Byte 0	Byte 1	Byte 2	Byte 3	Byte 4	Byte 5	Byte 6	Byte 7
Viscosity		Density		0xFFFF		Dielectric constant	
LSB	MSB	LSB	MSB	LSB	MSB	LSB	MSB

This frame appears once the sensor starts measurement and no longer.

- Data format:

	Viscosity	Density	Dielectric constant
Data length	2 bytes	2 bytes	2 bytes
Resolution	0.015625 cP per bit (0 offset)	0.00003052 g/cc per bit (0 offset)	0.00012207 per bit (0 offset)
Data range	0 to 1003.984375 cP	0 to 1.961 g/cc	0 to 7.842
Conversion	Visc (in cP) = DATA x 0.015625	Dens (in g/cc) = DATA x 0.00003052	Di = DATA x 0.00012207

Temperature output:

- PGN number: 0xFE0E
- Source address: 0x3F
- Update period (s): 30
- Frame:

Byte 0	Byte 1	Byte 2	Byte 3	Byte 4	Byte 5	Byte 6	Byte 7
0xFFFF		Average temperature		0xFFFF		0xFFFF	
LSB	MSB	LSB	MSB	LSB	MSB	LSB	MSB

Average temperature = Average of the temperature across the scan frequency.

- Data format:

	Temperature
Data length	2 bytes
Resolution	0.03125°C per bit (-273°C offset)
Data range	-273 to +1735°C
Conversion	Temp (°C) = (DATA x 0.03125) - 273

Diagnostic frame output:

- PGN number: 0xFF31
- Source address: 0x3F
- Update period (s): 30
- Frame:

Byte 0	Byte 1	Byte 2	Byte 3	Byte 4	Byte 5	Byte 6	Byte 7
Diag	0xFF	0xFFFF		0xFFFF		0xFFFF	
LSB	MSB	LSB	MSB	LSB	MSB	LSB	MSB

- Data format:

Status message code	Bit pos. (Diag)	Description	Potential root cause and issue	Criticality
Tuning fork – Impedance below normal or shorted to ground	1	Impedance below normal or shorted to ground	Over stress conditions Internal short circuit due to bad integration	++
Tuning fork – Impedance above normal or sensor damaged	2	Impedance above normal or shorted to high source	Broken tuning fork: -Operator misused -Oil velocity or viscosity too high Open circuit Welding degradation (high Temp. of the oil)	++
Tuning fork – ASIC over temperature conditions	3	Internal Temp. above 125°C	Bad integration	0
Fit – Algorithm failed to converge	4	Sensor not able to calculate parameters of the fluid	First measure after powered Out of parameters ranges: -Air bubbles -Water bubbles -Particles -Temp. ramp up too high -Conductive oil Broken tuning fork Welding degradation	-- -- ++
RTD – Resistance below normal or shorted to ground	5	RTD shorted to ground or damaged	Over stress conditions Internal short circuit due to bad integration	++
RTD – Resistance above normal or sensor damaged	6	RTD shorted to high source or damaged	Broken RTD: -Operator misused -Short circuit Open circuit Welding degradation, (high Temp)	++
RTD – Sensor temperature over temperature conditions	7	Measured Temp. by the RTD above 150°C	Temp. above 150°C (bad integration)	++
Internal – System error	8	Internal short circuit Elec. Boards degradation	Elec. damaged	++

++ = Critical value for the sensor integrity

0 = It can be a critical value (ageing of elec. comp). No damaged below 150°C.

-- = Not critical for the sensor

Diagnostic bit is set to '1' when error is detected.

Nominal functioning diag = 0x00 → 0000 0000

9. Cleaning procedure

Cleaning procedure:

- Raw cleaning with isopropanol
- Rinse with deionized water
- Drying (air injection can be used with flow 120 NI/min maximum)

Cleaning procedure in case of laboratory evaluation:

- Wipe main of oil with paper
- Rinse FPS sensing elements in a new oil (for example in beaker) at 100°C
- Wipe new oil
- If soot still present on sensing elements, rinse with hot temperature tap water
- Wipe with paper
- Blow on sensing elements to dry all water

CAUTION:

No rub, brush or physically contact the tuning fork sensor with a swab or brush.

When removed from the fluid, the probe has to be protected with provided cap.



NORTH AMERICA

Tel +1 800 522 6752
customercare.hmpt@te.com

EUROPE

Tel +31 73 624 6999
customercare.tlse@te.com

ASIA

Tel +86 0400 820 6015
customercare.shzn@te.com

te.com

TE Connectivity, TE connectivity (logo) and EVERY CONNECTION COUNTS are trademarks. All other logos, products and/or company names referred to herein might be trademarks of their respective owners.

The information given herein, including drawings, illustrations and schematics which are intended for illustration purposes only, is believed to be reliable. However, TE Connectivity makes no warranties as to its accuracy or completeness and disclaims any liability in connection with its use. TE Connectivity's obligations shall only be as set forth in TE Connectivity's Standard Terms and Conditions of Sale for this product and in no case will TE Connectivity be liable for any incidental, indirect or consequential damages arising out of the sale, resale, use or misuse of the product. Users of TE Connectivity products should make their own evaluation to determine the suitability of each such product for the specific application.

© 2020 TE Connectivity Corporation. All Rights Reserved.